

**Air Operated
Double Diaphragm Pumps**

for marine, industrial and mining applications

Teryair AODD pumps



Teryair manufactures a growing programme of pneumatic equipment and tools.

The equipment boasts of cutting edge features, comparable with the worlds best technologies, and compete successfully, feature for feature, with the industry leading brands and all this at competitive pricing.

Prominent among the equipment is the lineup of Teryair pneumatic air operated double diaphragm pump range. These pumps are being currently exported to over 40 countries, both as a teryair product and under private lable arrangements.

Last year teryair produced and sold over 9000 pumps and there is an ambitious growth plan in the coming years.

In India and around the world, teryair pumps are supported by strong no nonsense warranties and a promise of quick supply of spares.



Why Teryair AODD Pumps ?

Every pump is duration tested on a test bench at maximum load. Every pump performance parameter is recorded and traceable. This ensures unparalled pump reliability.

State of the air manufacturing under an ISO 9001:2015 enviornment.

Teryair pumps are CE and Ex certified.



Manufacturing Facilities

Research and Development

Teryair employs cutting edge design software and has trained engineers. They have been consistently improving the product by listening to user feedback. And new products are being launched every year.

Quality Assurance

Under the environment of ISO 9001 system, Teryair ensures that customer expectations are met and exceeded.

Infrastucture

Teryair is located on the outskirts of Mumbai, Indias thriving hub of commerce and industry. The factories are fully equipped to produce quality pneumatic equipment. All critical components are manufactured in house and this this way a strict control on production planning, timely delivery assurance and quality control is achieved.

Terryair AODD pumps

Terryair diaphragm pump advantages

- Pumps variety of fluids
- Easy startups, no priming
- No foaming or shearing of the product being pumped
- No decline in pumping efficiency over time, diaphragm replacement restores pump to original efficiency
- No damage due to running without lubrication (MaxFlo fitted pumps)
- Solid particle handling
- No damage when stalled or overloaded.
- Capable in submersible, flooded or negative suction orientations
- Explosion proof, ATEX Certified *
- No mechanical seals to replace
- Variable flow
- Suited for fixed and portable applications.

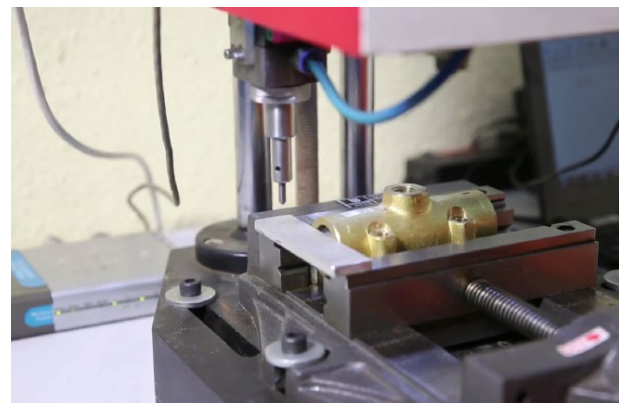

Diaphragm Pump Applications

Terylair pumps are versatile workhorses that can be used in a variety of pumping situations across numerous industries. Almost every type of liquid can be handled by these pumps.

Some of the typical industries are shown below



PACKAGING



PAINT



CHEMICAL



CONSTRUCTION



OFFSHORE



SHIPPING



CERAMIC



PHARMACEUTICALS



MINING

How to select right diaphragm pump for your application

Follow the steps outlined here to arrive at the best match

1 Gather your application data first, Following data is important.

Fluid to be pumped and its physical and chemical characteristics

- Viscosity
- pH value
- Specific Gravity
- Size of suspended solids, if any
- Discharge rate required
- Head at which discharge is required
- Suction head if any
- Pipe line diameter intended/existing and no. of bends

2 Select the diaphragm, Terryair offers the following material choices

Neoprene

An excellent general purpose diaphragm for use in non-aggressive applications such as water-based slurries, well water or sea water. Exhibits excellent flex life and low cost. Temperature range -18° C to +93° C (0° F to +200° F)

Nitrile

Excellent for applications involving petroleum / oil-based fluids such as leaded gasolines, fuel oils, non-synthetic hydraulic oils, kerosene, turpentine and motor oils. Temperature range -12° C to +82° C (+10° F to +180° F)

Viton

Excellent for use in applications requiring extremely hot temperatures. May also be used with aggressive fluids such as aromatic or chlorinated hydrocarbons and highly aggressive acids. Especially where high suction lift is important. Temperature range -40° C to +177° C (-40° F to +350° F)

PTFE

Excellent choice when pumping highly aggressive fluids such as aromatic or chlorinated hydrocarbons, acids, caustics, ketones and acetates. Temperature range +4° C to +104° C (+40° F to +220° F)

Santoprene

Good abrasion resistance. Low cost. Can handle mild acids and alkalis well. Excellent low cost alternative to ptf. Excellent suction capabilities Excellent general purpose diaphragm. Temperature range -40° C to +107° C (-40° F to +225° F)

Hytrel

Good abrasion resistance. Low cost. . Excellent suction capabilities Excellent general purpose diaphragm. Temperature range -29° C to +104° C (-20° F to +220° F)

3 Once the diaphragm material is chosen, select the correct material of construction of the pump. terryair offers following material of construction choices:

Aluminium

Good for fluids having pH between 5.5 and 8.5 Temperature only limited only by diaphragm limits

Stainless Steel 316L

Good for stronger concentrated acids and alkaline fluids. Stainless Steel is durable and rugged. Temperature only limited by diaphragm limits

Polypropylene

Good alternative low cost choice where fluid is compatible especially chemical compatibility and temperatures. Polypropylene is good between Temperature ranges of 0° C to 79° C and +32° F to +175° F.

Ductile Iron

Ideal for underground and overground rugged duty especially where underground duty calls for a no-aluminium construction. Economic alternative to SS in these cases.

4 Now establish the TOTAL Head using the below calculation.

TOTAL Head = Specific gravity X (Suction Head + Discharge head)

Now add roughly about 10 feet for each 90 degree Bend, and allow for friction within the pipe too.

5 Check Solids Handling Capability

Maximum slurry particle size must not be greater than the pump's solids passage capability. A strainer may be placed on the inlet line to eliminate particles larger than the pump's capability. Please refer to individual specifications for you pump's specific solids passage capabilities.

6 Establish Pump Model most suited

For example

To achieve a flow of 120 liters per minute at a head of 120 feet.

If we select DP40 Pump, from its graph we see that this pump will need about 25 cfm of air at about 70 PSI supply pressure.

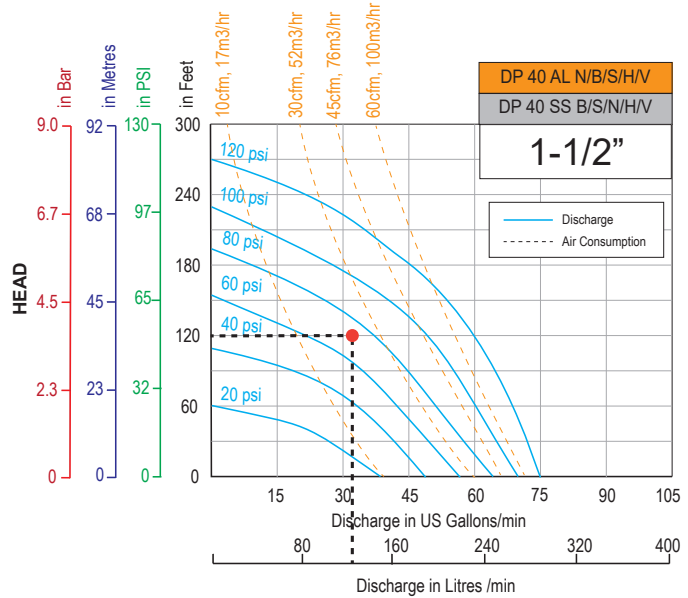

Nomenclature

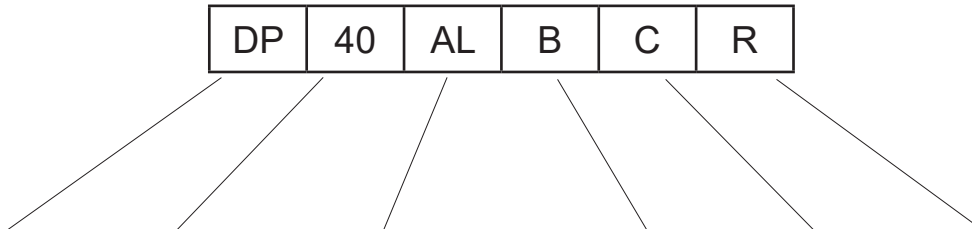

Air Valve Type	Pump Size	Material of Construction	Material of Diaphragm	Bolted or Clamped	Threading on Inlet and Outlet
DP - Classic	06 - 1/4"	AL - Aluminium	B - Nitrile N - Neoprene S - Santoprene	B - Bolted	R- NPT
	12 - 1/2"				
ADP - Advanced	25 - 1"	SS - Stainless Steel 316L	T - PTFE V - Viton H - Hytrel	C - Clamped	G - BSPT
SDP - MaxFlo	40 - 1 - 1/2"	PP - Polypropylene			P - BSPP
	50 - 2 "	CI - Ductile Iron	F - Flanged		
	75- 3"				
	100 - 4"				

Notes:
MaxFlo M : Heavy Duty Mining version of MaxFlo valve system
MaxFlo SS : MaxFlo valve system for chemical handling

Teryair Air Distribution Valve Technology

The heart of any diaphragm pump is the air distribution valve. Teryair valves are designed to maximize air efficiencies, using less air to pump more.

There are other features that are desirable depending on the application. Stall free, lubrication free or corrosion resistant.

Teryair has carefully combined correct valves with aluminium, SS or PP pump materials and has pre selected valve+pump combinations that are fine tuned for applications.

For example Teryair matches popular combinations of aluminium with classic valves for the rough and ready portable use for marine applicaitons.

To know more about teryair valve technology, read below

Classic Valve

Rugged bronze construction and internal spools also are hard anodized metal. Specifically designed for rough outdoor and portable use. Interchangeable with other popular brands.



Classic valves have a standard Generic Interface

Advanced Valve

Best matched with Teryair PP pumps, they have a precision shift mechanism and a PTFE and viton seal. They are lubrication free and constructed from high density advanced plastics.

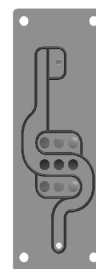
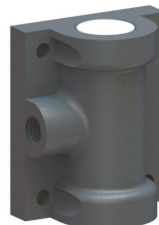

MaxFlo valves have a standard Generic Interface

MaxFlo Valve

Teryair's most advanced valve. Very efficient usage of air, high output of fluid. Available in aluminium and SS. PTFE and Viton sealing. Lurication free and stall free. These valves have a long service life. Interchangeable with other popular brands.



Aluminium Pumps

Aluminium Pumps are lightweight and easy to move about.

These aluminium constructed pumps are commonly combined with Neoprene, Nitile or Santoprene elastomers. With these elastomers they are ideal for pumping of water and water based fluids, non aggressive fluids, oily fluids and fluids having low acidic or alkali concentrations

Aluminium Pumps offer a relatively low cost solution to many pumping applications.

For this purpose the main industries that choose Aluminium pumps are; Paints, Marine, Mining, Ceramic and Waste Water/Pollution mangement.



SDP 50 ALX

Nominal Size	Model Number	Maximum Discharge, Litres/min (gpm)	Suction Head Dry, mtrs (feet)	Suction Head Wet, mtrs (feet)	Pump Weight, Kgs (Lbs)	Maximum Solid Handling Dia, mm (inches)	Air Distribution system	Bolted or Clamped	Performance graphs, see page Number
1/4"	SDP 06 AL N/B/S/H/V*	18(4.8)	3.3(10.8)	9(30)	1.9(4.2)	0.4(1/64")	MaxFlo	Clamped	15
	SDP 06 ALT*	18(4.8)	4(13)	9.5(31)	1.9(4.2)	0.4(1/64")	MaxFlo	Clamped	16
1/2"	DP 12 AL N/B	51(14)	1.5(6)	9.5(31)	4.4(9.7)	1.6(1/16")	Classic	Bolted	13
	DP 12 ALT	50(13)	2.7(9)	9(30)	4.4(9.7)	1.6(1/16")	Classic	Bolted	14
	SDP 12 AL N/B/S/H/V*	55(15)	5.5(18)	9.5(31)	5.1(11.2)	1.6(1/16")	MaxFlo	Clamped	15
	SDP 12 ALT*	51(14)	4(13)	9.5(31)	5.1(11.2)	1.6(1/16")	MaxFlo	Clamped	16
1"	DP 25 AL N/B/S/H/V	125(33)	5(16)	9.5(31)	9.1(20)	3.2(1/8")	Classic	Clamped	13
	DP 25 ALT	90(24)	2(6.5)	9.5(31)	9.1(20)	3.2(1/8")	Classic	Clamped	14
	SDP 25 AL N/B/S/H/V*	162(43)	5.5(18)	9(30)	14.2(30.8)	3.2(1/8")	MaxFlo	Clamped	15
	SDP 25 ALT*	147(39)	2.7(10)	9(30)	14.2(30.8)	3.2(1/8")	MaxFlo	Clamped	16
1-1/2"	DP 40 AL N/B/S/H/V	263(70)	5.5(18)	8.5(28)	15(33)	4.8(3/16")	Classic	Clamped	13
	DP 40 ALT	223(59)	2.7(9)	8.5(28)	15.5(34)	4.8(3/16")	Classic	Clamped	14
	SDP 40 AL N/B/S/H/V	273(72)	5.5(18)	8(26)	17(37)	4.8(3/16")	MaxFlo	Clamped	15
	SDP 40 ALT	232(61)	3.6(12)	8.5(28)	17.5(38.5)	4.8(3/16")	MaxFlo	Clamped	16
2"	DP 50 AL N/B/S/H/V	586(155)	6.4(21)	9.5(31)	26.5(58)	6.4(1/4")	Classic	Clamped	13
	DP 50 ALT	424(112)	3.6(12)	9.5(31)	26(57)	6.4(1/4")	Classic	Clamped	14
	SDP 50 AL N/B/S/H/V	592(156)	6.7(22)	8.5(28)	29(64)	6.4(1/4")	MaxFlo	Clamped	15
	SDP 50 ALT	471(125)	4.6(15)	9.5(31)	29(64)	6.4(1/4")	MaxFlo	Clamped	16
3"	DP 75 AL N/B/S/H/V	834(220)	5.5(18)	9.5(31)	52.5(115.5)	9.5(3/8")	Classic	Clamped	13
	DP 75 ALT	668(177)	3.5(11.5)	8.5(28)	52(114)	9.5(3/8")	Classic	Clamped	14
	SDP 75 AL N/B/S/H/V	864(228)	6.5(21)	9(30)	54(118)	9.5(3/8")	MaxFlo	Clamped	15
	SDP 75 ALT	692(182)	4.6(15)	9.5(31)	54(118)	9.5(3/8")	MaxFlo	Clamped	16

Notes

1. N/B/S/H/V in Model Number indicates choice of N-Neoprene , B-Nitrile, S-Santoprene, H - Hytrel or V - Viton with matching seals
2. T in Model Number indicates PTFE with aluminium seats
3. All above mentioned pumps have aluminium wetted parts
4. PTFE models have a metal seal and PTFE sealing rings.
5. All above models are available with either BSPT, NPT or BSPP Threading, see Nomenclature.
6. Dimension Drawings are available, STEP files also available
7. MaxFlo valves are constructed from Aluminium, Acetal and CFT sealing rings
8. Classic valves are constructed from Bronze and Hard Anodized Aluminium.
9. * indicates Models shipping from Jan 2021.
10. All above pumps have an aluminium centre section

Aluminium Pumps



SDP06 ALX



SDP12 ALX



DP12 ALX



DP25 ALX



SDP25 ALX



DP40 ALX



SDP40 ALX



DP50 ALX



SDP50 ALX



DP75 ALX

Stainless Steel 316LPumps

Stainless Steel constructed pumps are used in applications which demand high pumping performance, combinations of hot and corrosive fluids, both acidic and alkali. They are the ultimate choice for durable long life performance.

These pumps are usually combined with highly capable and corrosion resistant diaphragms, mainly PTFE and often Viton and Santoprene.

With these elastomers they are ideal for pumping of fluids like benzyl diacetone, phosphoric acid, ferric sulfate, isopropyl chloride, transformer oils and many other similar fluids. Excellent choice when pumping highly aggressive fluids such as aromatic or chlorinated hydrocarbons, acids, caustics, ketone and acetates.

These pumps find wide applications across industries, some popular industries are Chemicals, Pharma, Food/Beverage and Electronic manufacturing.

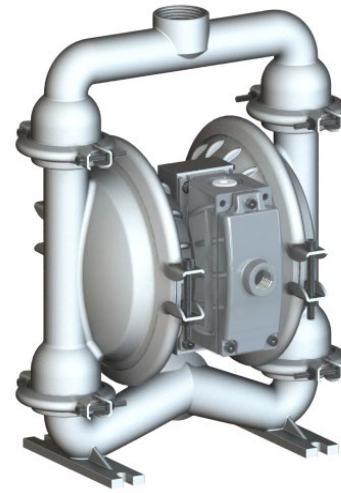

SDP40 SSX

Nominal Size	Model Number	Maximum Discharge, Litres/min (gpm)	Suction Head Dry, mtrs (feet)	Suction Head Wet, mtrs (feet)	Pump Weight, Kgs (Lbs)	Maximum Solid Handling Dia, mm (inches)	Air Distribution system	Bolted or Clamped	Performance graphs, See page Number	Centre section Material
1/4"	SDP 06 SS N/B/S/H/V*	18(5)	3.3(10.8)	9(30)	4.5 (10)	0.4(1/64")	MaxFlo-SS	Clamped	15	SS
	SDP 06 SST*	18(5)	4(13)	9.5(31)	4.5 (10)	0.4(1/64")	MaxFlo-SS	Clamped	16	SS
1/2"	SDP 12 SS N/B/S/H/V*	55(15)	5.5(18)	9.5(31)	10(22)	1.6(1/16")	MaxFlo-SS	Clamped	15	SS
	SDP 12 SST*	51(14)	4(13)	9.5(31)	10(22)	1.6(1/16")	MaxFlo-SS	Clamped	16	SS
1"	DP 25 SS B/S/N/H/V	125(33)	5(16)	9.5(31)	13.6(30)	3.2(1/8")	Classic	Clamped	13	Aluminium
	DP 25 SST	90(24)	2(6.5)	9.5(31)	13.6(30)	3.2(1/8")	Classic	Clamped	14	Aluminium
	SDP 25 SS B/S/N/H/V*	162(43)	5.5(18)	9(30)	18(40)	3.2(1/8")	MaxFlo	Clamped	15	Aluminium
	SDP 25 SST*	147(39)	2.7(10)	9(30)	18(40)	3.2(1/8")	MaxFlo	Clamped	16	Aluminium
1-1/2"	DP 40 SS B/S/N/H/V	263(70)	5.5(18)	8.5(28)	23.2(51)	4.8(3/16")	Classic	Clamped	13	Aluminium
	DP 40 SST	223(59)	2.7(9)	8.5(28)	23.2(51)	4.8(3/16")	Classic	Clamped	14	Aluminium
	SDP 40 SS B/S/N/H/V	273(72)	5.5(18)	8(26)	28.5(63)	4.8(3/16")	MaxFlo	Clamped	15	Aluminium
	SDP 40 SST	232(61)	3.6(12)	8.5(28)	28.5(63)	4.8(3/16")	MaxFlo	Clamped	16	Aluminium
2"	DP 50 SS B/S/N/H/V	586(155)	6.4 (21)	9.5(31)	42(92)	6.4(1/4")	Classic	Clamped	13	Aluminium
	DP 50 SST	424(112)	3.6(12)	9.5(31)	42(92)	6.4(1/4")	Classic	Clamped	14	Aluminium
	SDP 50 SS B/S/N/H/V	592(156)	6.7(22)	8.5(28)	48(105)	6.4(1/4")	MaxFlo	Clamped	15	Aluminium
	SDP 50 SST	471(125)	4.6(15)	9.5(31)	48(105)	6.4(1/4")	MaxFlo	Clamped	16	Aluminium

Notes

1. B/S/N/H/V indicates choice of B-Nitrile, S-Santoprene, N-Neoprene, H-Hytril and V-Viton with matching seals
2. T indicates PTFE with SS seats
3. All above mentioned pumps have SS316L wetted parts
4. PTFE models have a metal seal and PTFE sealing rings.
5. All above models are available with either BSPT, NPT or BSPP Threading, see nomenclature
6. Dimension Drawings are available, STEP files also available
7. MaxFlo valves are constructed from Aluminium or SS316L, Acetal and CFT sealing rings
8. Classic valves are constructed from Bronze and Hard Anodized Aluminium.
9. MaxFlo valves on SS models are SS-HDPP-CFT for corrosion resistance.
10. * indicates Models shipping from Jan 2021
11. MaxFlo SS : MaxFlo valve system for chemical handling.

Stainless Steel 316LPumps



SDP06 SSX

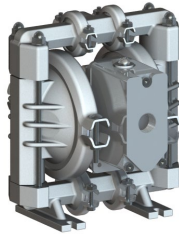

SDP12 SSX

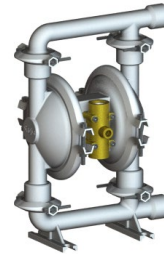

DP25 SSX

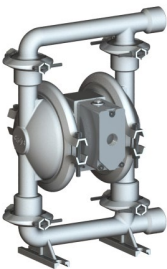

SDP25 SSX

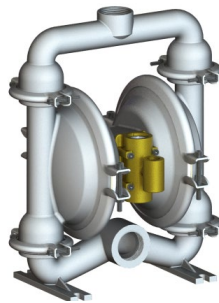

DP40 SSX

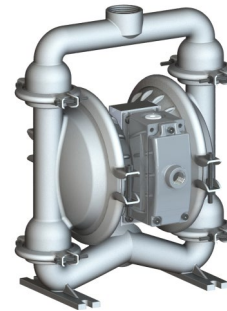

SDP40 SSX

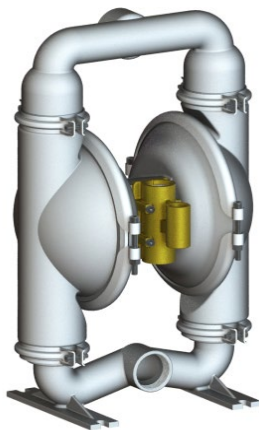

DP50 SSX

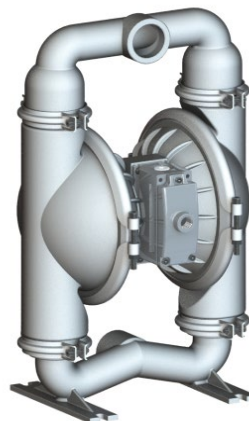

SDP50 SSX

Ductile Iron Pumps



SDP 50 CIX



SDP 75 CIX

Teryairs Cast Iron pumps are constructed out of a special tough spheroidal graphite Iron, to withstand the toughest duty outdoors. They are primarily designed for use in underground mining atmospheres, all pumps shown here have a Mining ATEX approval.

They employ a special version of the air valve system which contains no aluminium, so as to be compatible with mining regulations.

All diaphragm options are available, including the popular BunaN and Hytrel versions.

Skid mounting, inlet strainer bases and frames are all available.

Applications include removal of underground water / drift water from mine sites, transfer of muck, slime and slurry and oil transfer and utility use.

Nominal Size	Model Number	Maximum Discharge, Litres/min (gpm)	Suction Head Dry, mtrs (feet)	Suction Head Wet, mtrs (feet)	Pump Weight, Kgs (Lbs)	Maximum Solid Handling Dia, mm (inches)	Air Distribution system	Bolted or Clamped	Performance graphs, See page Number	Centre section Material
2"	SDP 50 CI B/S/N/H/V*	592(156)	7.3(24)	9.5(31)	48(105)	6.4(1/4")	MaxFlo-M	Clamped	15	Ductile Iron
3"	SDP 75 CI B/S/N/H/V*	864(228)	5.5(18)	9.5(31)	90(198)	9.5(3/8")	MaxFlo-M	Clamped	15	Ductile Iron
4"	SDP 100 B/H/V*	1100(291)	4(13)	9(30)	220 (485)	35(1-1/8")	MaxFlo-M	Clamped	coming soon	Ductile Iron

1. B/S/N/H/V indicates choice of B-Nitrile, S-Santoprene, N-Neoprene, H-Hytrel and V-Viton with matching seals
2. All above mentioned pumps have Ductile Iron wetted parts
3. All above models are available with either BSPT, NPT or BSPP Threading, see nomenclature
4. Dimension Drawings are available, STEP files also available
5. MaxFlo M valves are constructed from Ductile Iron.
6. * indicates Models shipping from Jan 2021
7. MaxFlo M : Heavy Duty Mining version of MaxFlo valve system

Performance Graphs

Aluminium or Stainless Steel Construction
Neoprene, Nitrile, Santoprene, Viton or Hytrel fitted
Classic Valve

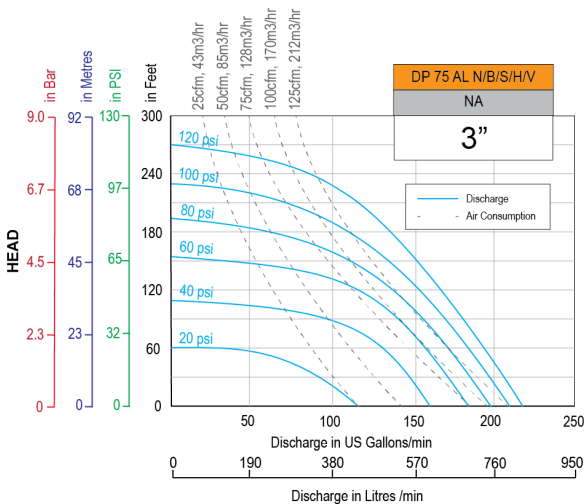
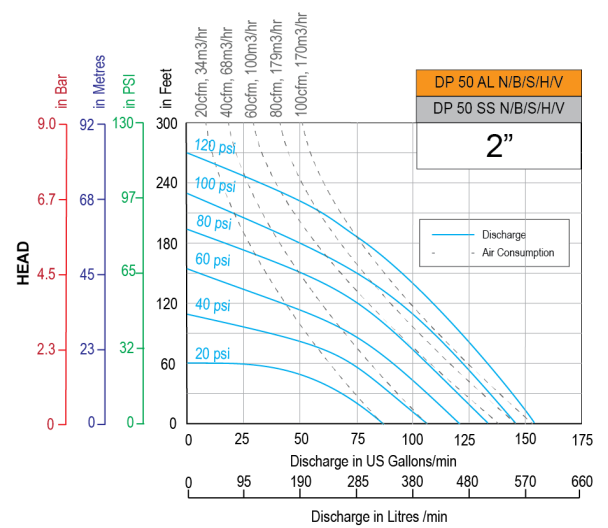
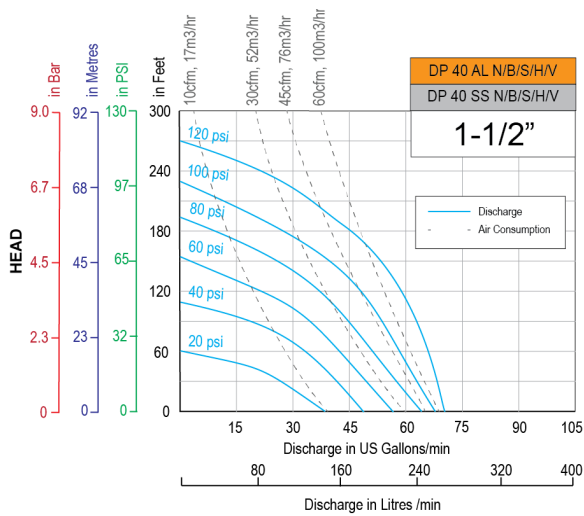
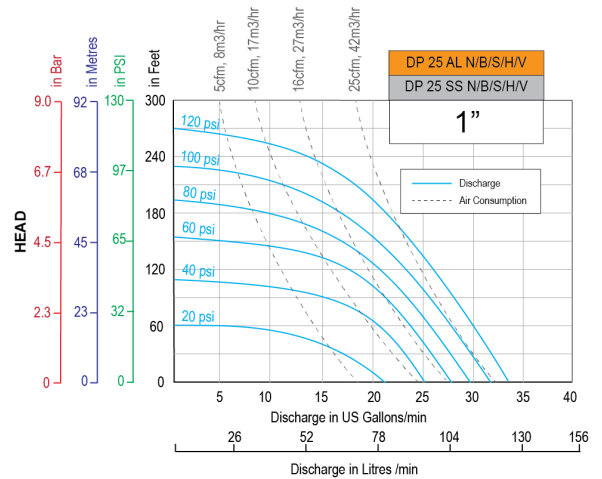
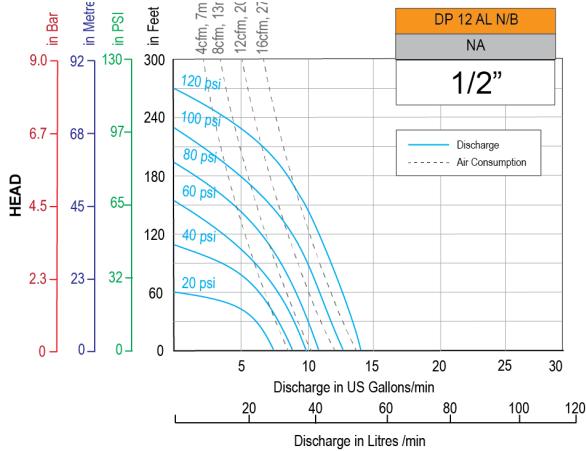

Note
Performance Curves are measured pumping water at 20°C at teryair testing Lab. External circumstances might affect performance.

Performance Graphs

Aluminium or Stainless Steel Construction
PTFE fitted
Classic Valve

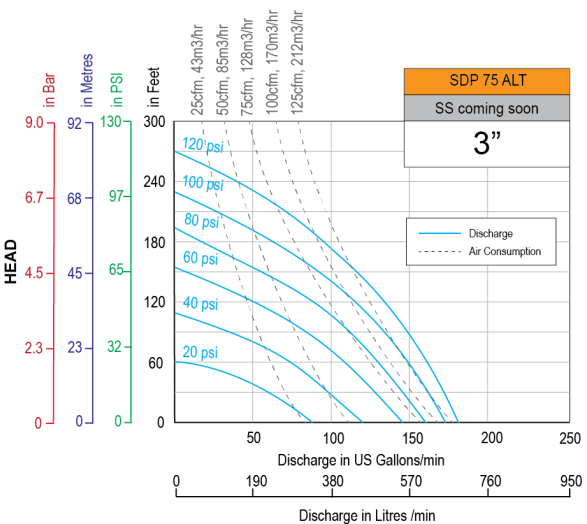
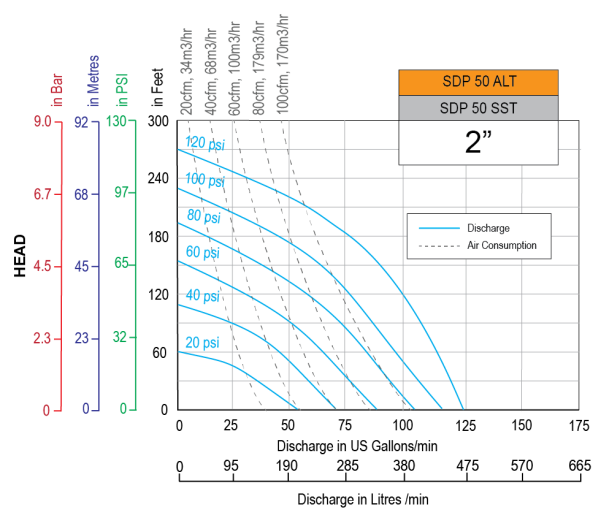
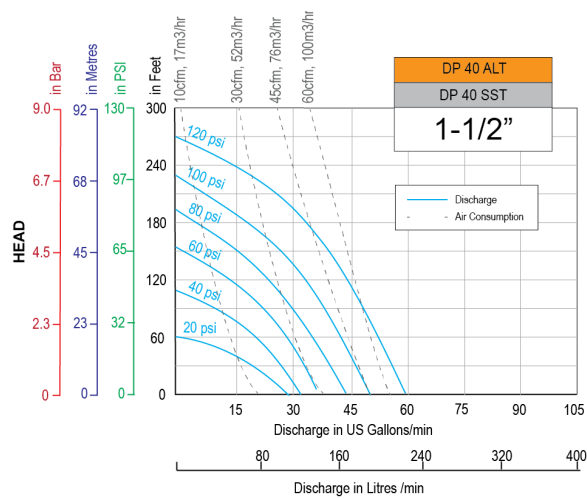
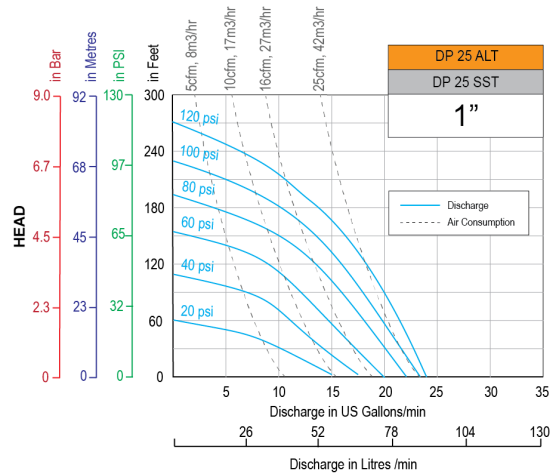
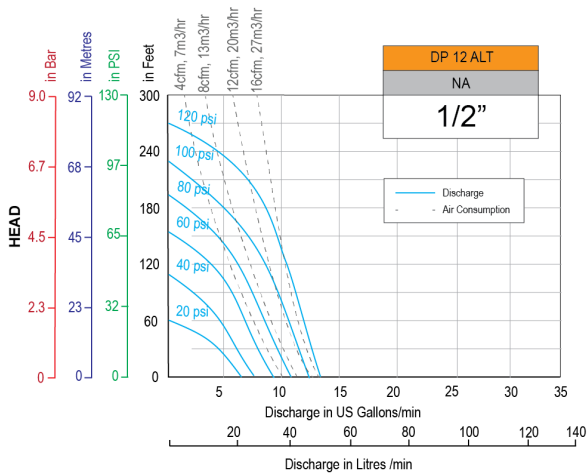

Note
Performance Curves are measured pumping water at 20°C at teryair testing Lab. External circumstances might affect performance.

Performance Graphs

Aluminium or Stainless Steel or Ductile Iron Construction
Neoprene, Nitrile, Santoprene, Viton or Hytrel fitted
MaxFlo Valve

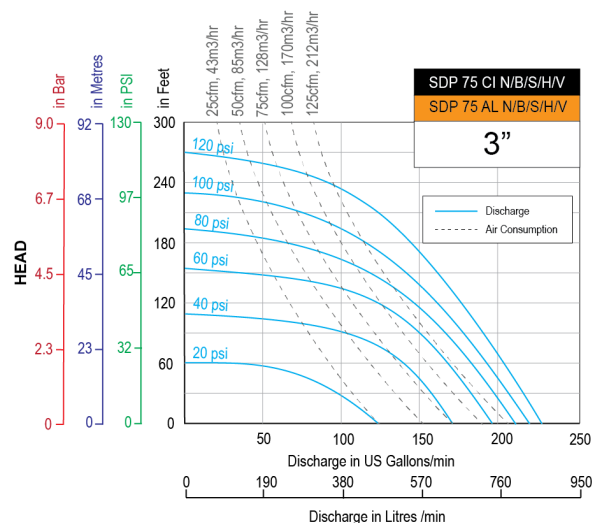
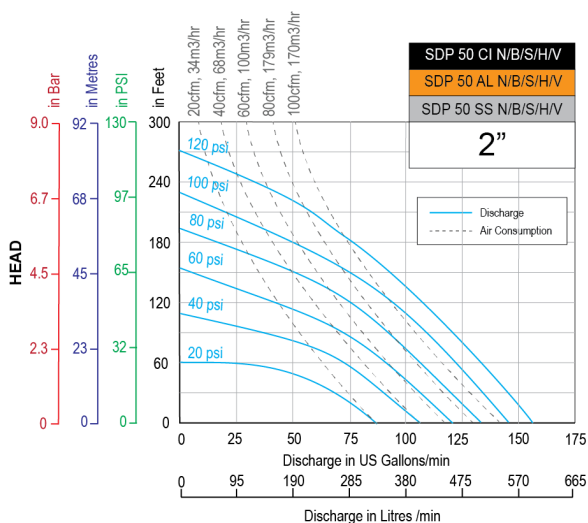
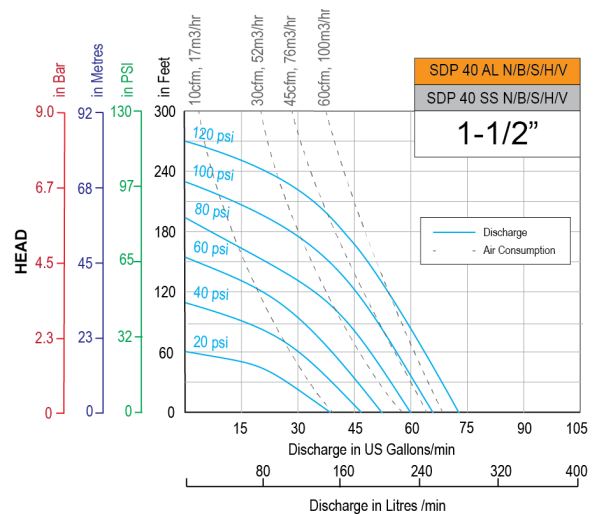
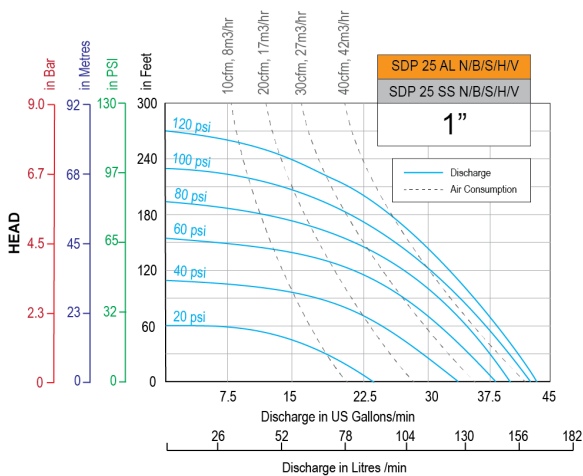
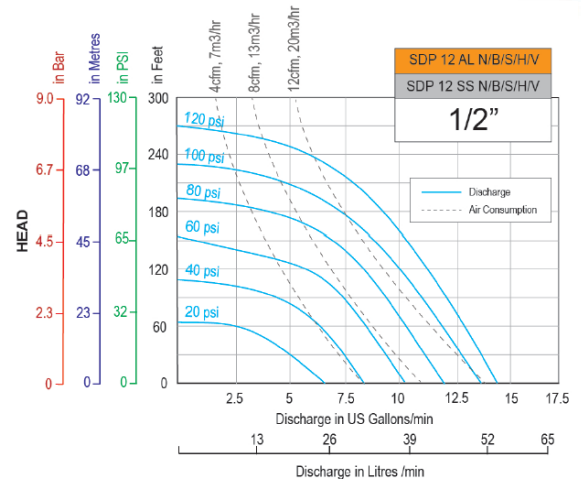
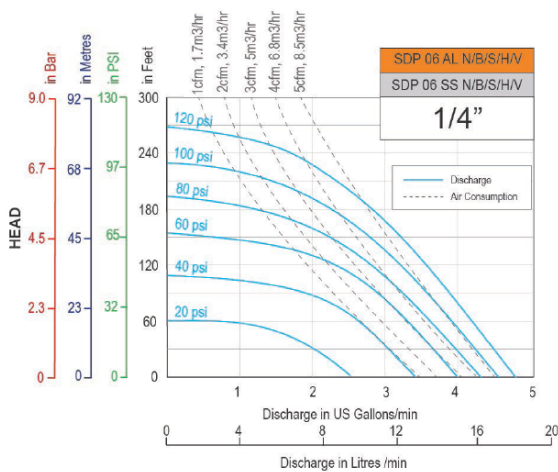

Note
Performance Curves are measured pumping water at 20degC at teryair testing Lab. External circumstances might affect performance.

Performance Graphs

Aluminium or Stainless Steel Construction
PTFE fitted
MaxFlo Valve

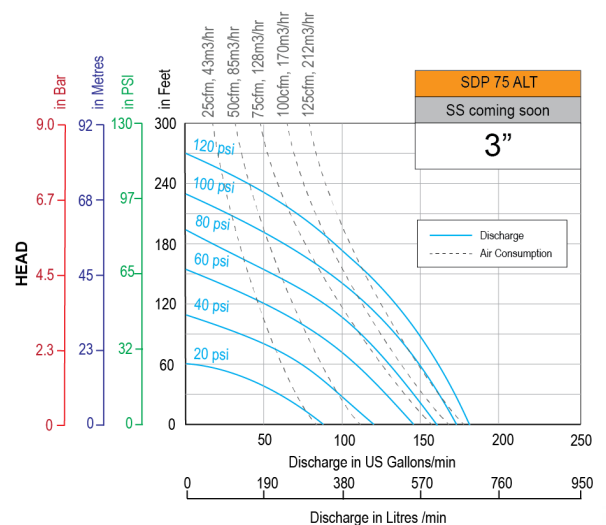
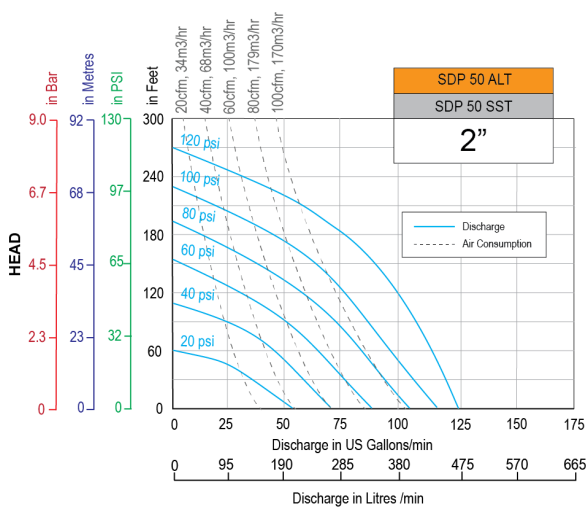
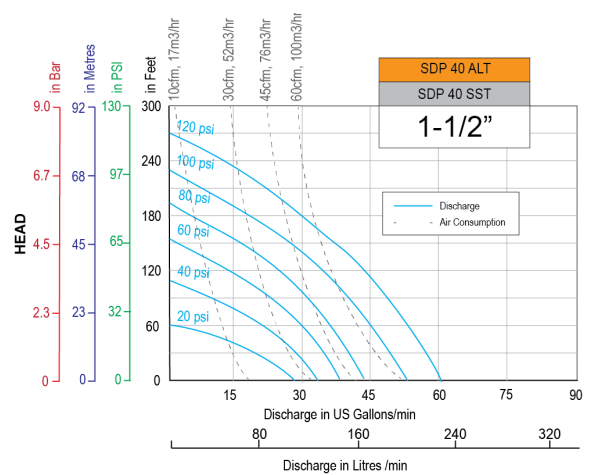
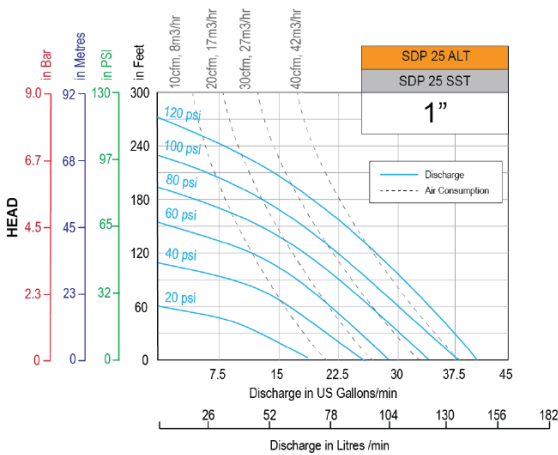
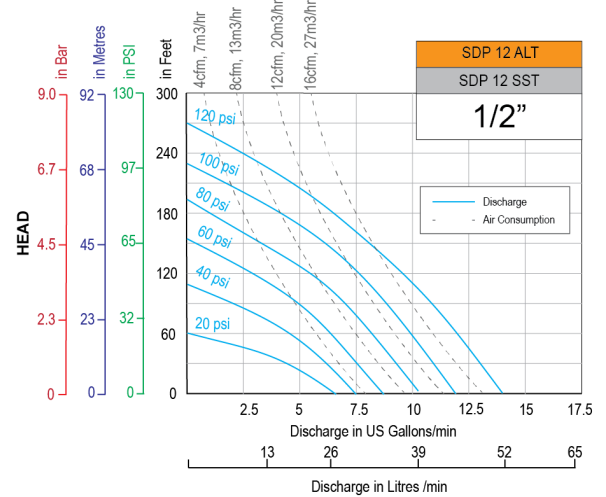
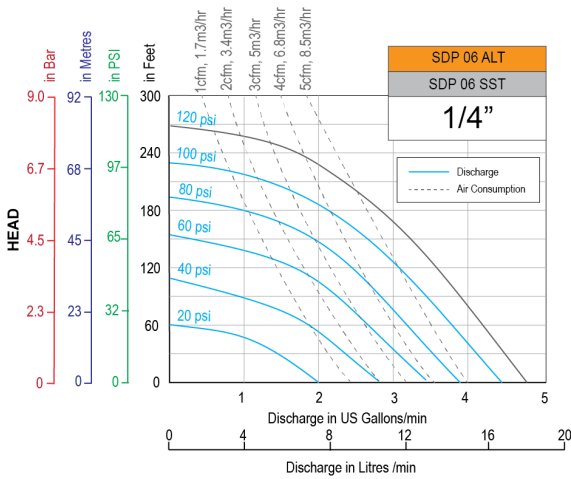

Note
Performance Curves are measured pumping water at 20°C at teryair testing Lab. External circumstances might affect performance.

Polypropylene Pumps

Polypropylene pumps or PP pumps are lower in cost to Stainless Steel and can be a suitable alternative to a majority of the applications. In applications which need hot operability or outdoor rough environments, Stainless Steel is still preferred.

These pumps are usually combined with PTFE and often Viton and Santoprene diaphragms are also used.

With these elastomers they are ideal for pumping of fluids like benzyl, diacetone, phosphoric acid, ferric sulfate, isopropyl chloride, transformer oils and many other similar fluids.

These pumps find wide applications across industries, some popular industries are Chemicals, Pharma and Electronic manufacturing.



ADP25 PPT

Nominal Size	Model Number	Maximum Discharge, Litres/min (gpm)	Material of Diaphragm, Balls, Seals and Seats	Suction Head Dry, mtrs (feet)	Suction Head Wet, mtrs (feet)	Pump Weight, Kgs (Lbs)	Maximum Solid Handling Dia, mm (inches)	Air Distribution system	Bolted or	Performance graphs, see page Number	Centre section
1/4"	ADP 06 PPT	20(5)	PTFE	4 (13)	9 (30)	1.2 (2.6)	0.4 (1/64")	Advanced	Bolted	19	Polypropylene
1/2"	ADP 12 PPT	53(14)	PTFE	3 (10)	8.5 (28)	2.7 (6)	1.6 (1/16")	Advanced	Bolted	19	Polypropylene
	ADP 15 PPT	58(15.6)	PTFE	3 (10)	8.5 (28)	4.5 (10)	1.6 (1/16")	Advanced	Bolted	19	Polypropylene
1"	ADP 25 PPT	129(34)	PTFE	2.7 (9)	9.5(31)	15 (33)	3.2(1/8")	Advanced	Bolted	19	Polypropylene
	ADP 25 PPS	129(34)	Santoprene and PTFE Balls	5.5(18)	9.5(31)	15(33)	3.2(1/8")	Advanced	Bolted	19	Polypropylene
1-1/2"	DP 40 PPT	299(79)	PTFE	2.7(9)	8.5 (28)	10(22)	4.8(3/16")	Classic	Bolted	19	Aluminum
	ADP 40 PPT	299(79)	PTFE	2.7 (9)	8.5 (28)	8.2 (18)	4.8(3/16")	Advanced	Bolted	19	Polypropylene
2"	SDP 50 PPT	496(131)	PTFE	3.5(11)	8.5(28)	28 (62)	6.4 (1/4")	MaxFlo	Bolted	19	Aluminum

Notes

1. T indicates PTFE, S-Santoprene.
2. All above mentioned pumps have Polypropylene wetted parts
3. All above models are available with either BSPT, NPT or BSPP Threading, see nomenclature
4. Dimension Drawings are available, STEP files also available
5. MaxFlo valves are constructed from Aluminium or SS316L, Acetal and CFT sealing rings
6. Classic valves are constructed from Bronze and Hard Anodized Aluminium.

Polypropylene Pumps



ADP06PPT

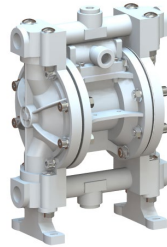

ADP12PPT

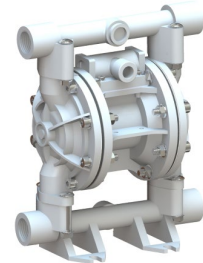

ADP15PPT



ADP25PPT

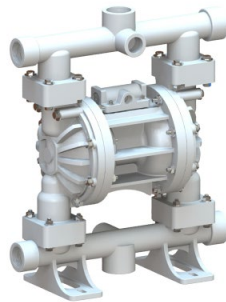

ADP40PPT



DP40PPT

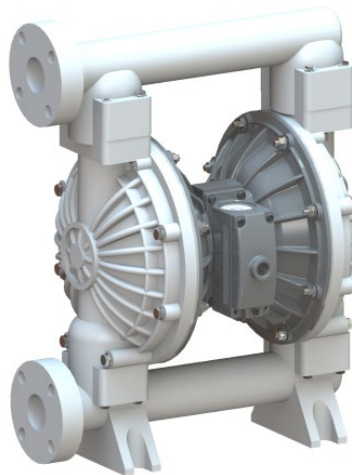

SDP50PPB

Performance Graphs

Polypropylene Constructed
PTFE of Santoprene fitted
Advanced or MaxFlo Valves

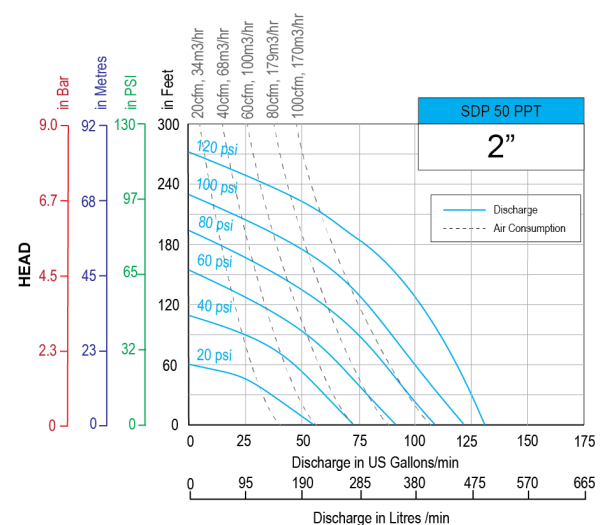
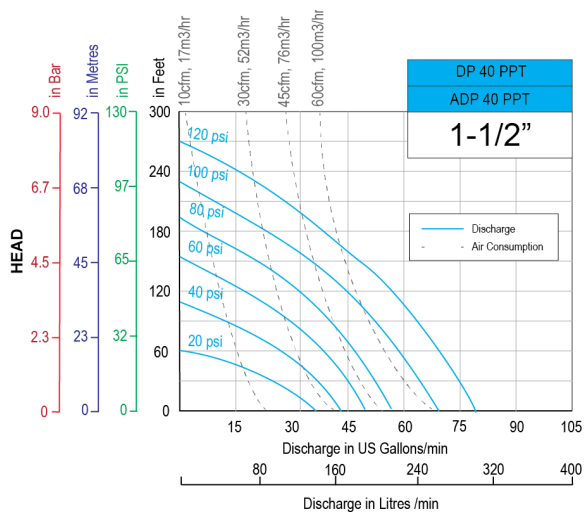
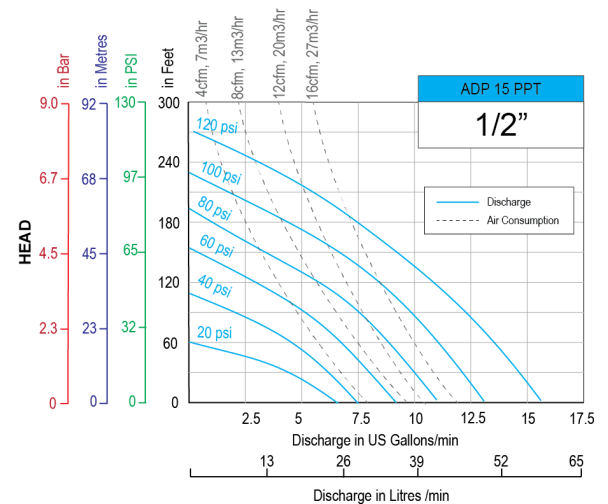
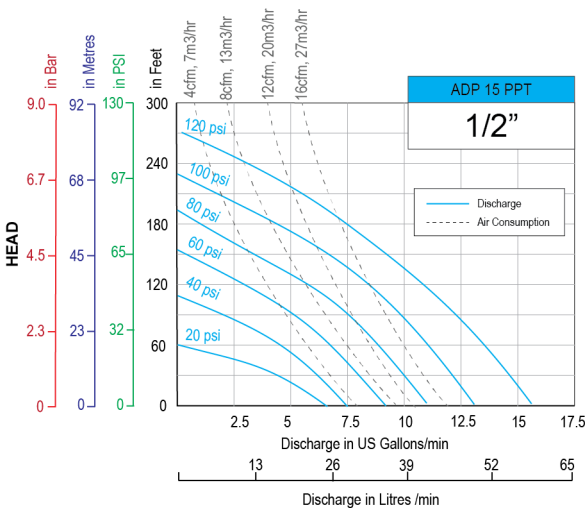
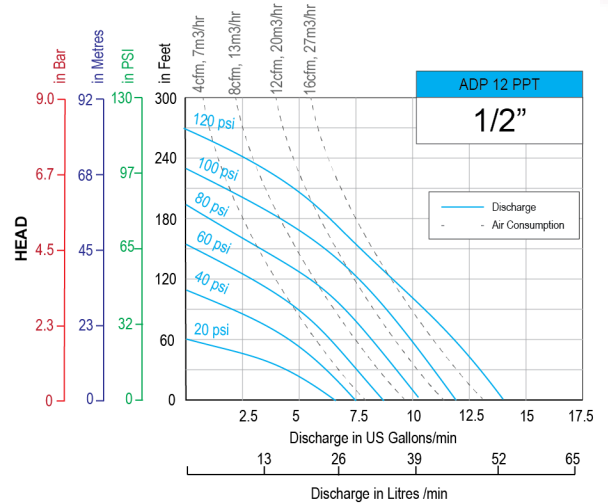
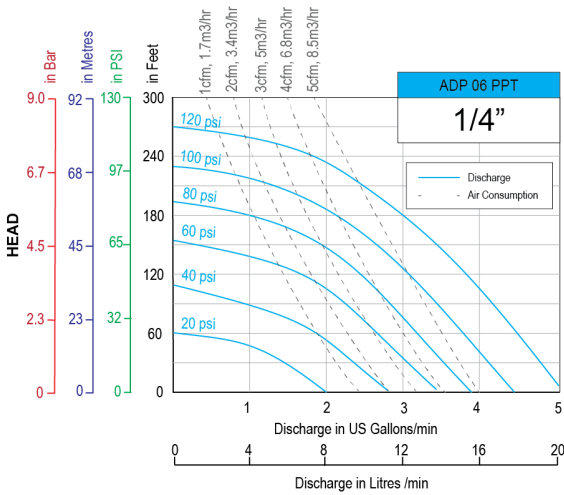

Note
Performance Curves are measured pumping water at 20°C at teryair testing Lab. External circumstances might affect performance.

Cam lock Couplings

Useful and quick way to securely connect hoses to pumps, and capable of withstanding required pressures without leakages. Available in both Aluminium and SS. Shown F type Plugs are with BSPT threads.



F type Plug



C type Socket

Aluminium

Part No	Description	Part No	Description
351751-G	1/2" F Type Plug	352001A	1/2" C Type Socket
351752-G	3/4" F Type Plug	352001	3/4" C Type Socket
351753	1" F Type Plug	352002	1" C Type Socket
351754	1-1/4" F Type Plug	352003	1-1/4" C Type Socket
351755	1-1/2" F Type Plug	352004	1-1/2" C Type Socket
351756-G	2" F Type Plug	352005	2" C Type Socket
351757	2-1/2" F Type Plug	352006	2-1/2" C Type Socket
351758	3" F Type Plug	352007	3" C Type Socket

Stainless Steel

Part No	Description	Part No	Description
351781	1/2" F Type Plug	352031A	1/2" C Type Socket
351782	3/4" F Type Plug	352031	3/4" C Type Socket
351783	1" F Type Plug	352032	1" C Type Socket
351784 - G	1-1/4" F Type Plug	352033	1-1/4" C Type Socket
351785	1-1/2" F Type Plug	352034	1-1/2" C Type Socket
351786	2" F Type Plug	352035	2" C Type Socket
351787	2-1/2" F Type Plug	352036	2-1/2" C Type Socket
351788	3" F Type Plug	352037	3" C Type Socket

Notes

XXXXXX-R = NPT Threading

XXXXXX-G = BSPT Threading

XXXXXX-P = BSPP Threading

When ordering replace G with R or P as required.

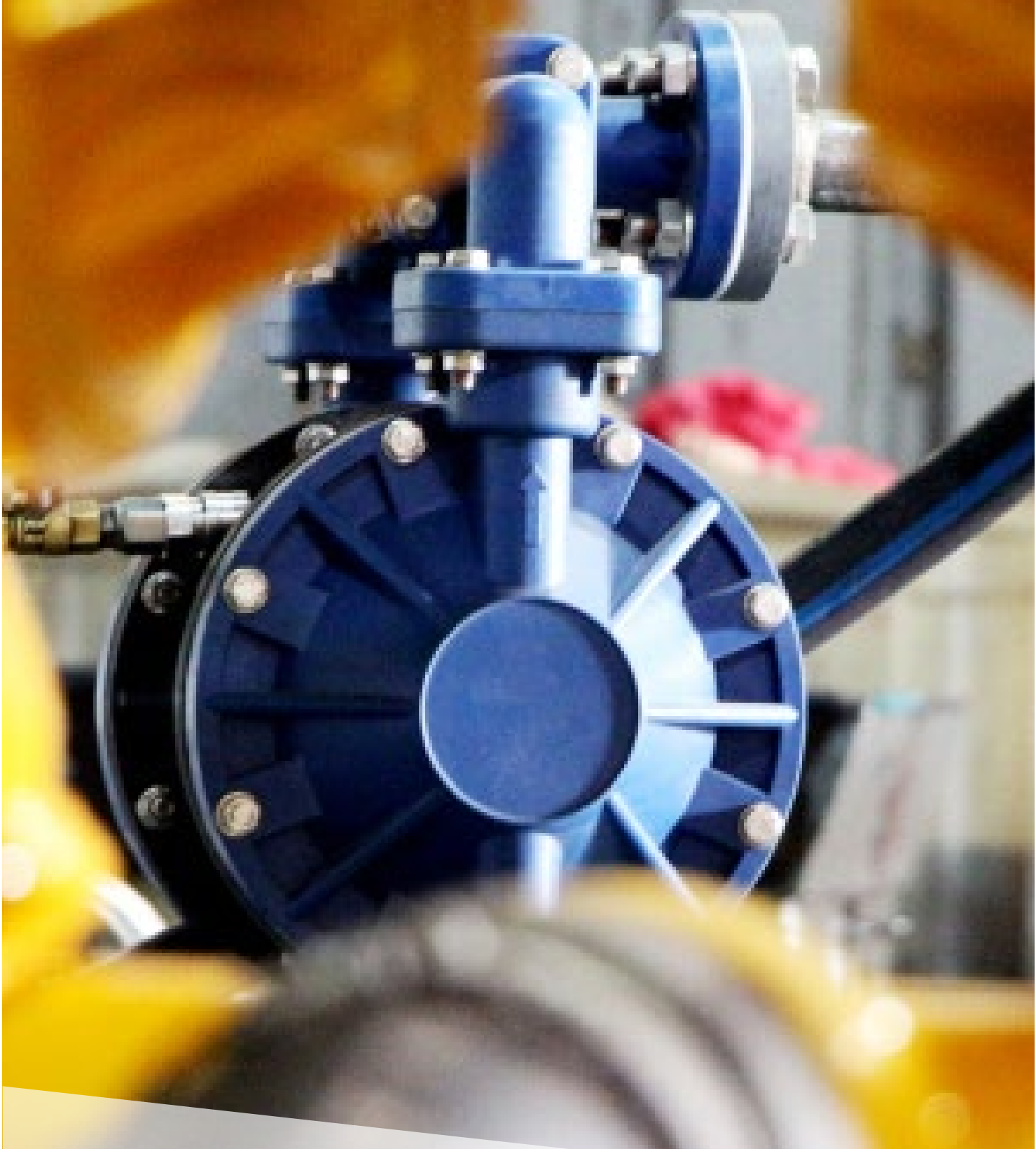

Teryair Equipment Pvt. Ltd.

Factory
A1, Tirupathi Udyog Nagar
Sativali Road, Vasai East
Palghar 401208, Maharashtra
INDIA

Sales
C609, ONEBKC
BKC, Bandra East, Mumbai
400051, Maharashtra
INDIA

email : info@teryair.com
Tel : +91 88790 32775
Tel : +91 86696 10364
web : www.teryair.com

