

SDP 12 ALX

MAX DISCHARGE
0-55 litres/minute

SIZE, MATERIAL
1/2", Aluminium

WEIGHT
5.1 Kgs

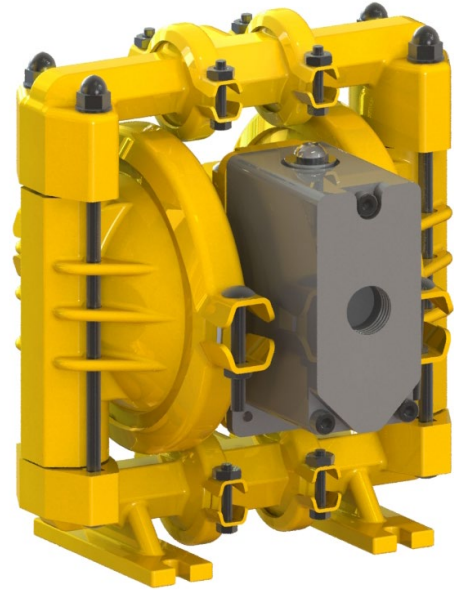

AIR OPERATED DIAPHRAGM PUMP

These aluminium constructed pumps are commonly combined with Nitrile, Santoprene, Hytrel or PTFE Elastomers. With these elastomers they are ideal for pumping of water and water-based fluids, non-aggressive fluids, oily fluids and fluids having low acidic or alkali concentrations

Aluminium Pumps offer a relatively low-cost solution to many pumping applications. For this purpose, the main industries that choose Aluminium pumps are Paints, Marine, Mining, Ceramic and Wastewater/Pollution management.



Diaphragm Options 'X'

Santoprene
Hytrel
PTFE



Approvals and Certifications

All Teryair pumps are CE marked and manufactured under an ISO 9001:2015 Quality system by SGS. All Teryair aluminum, Ductile iron, and Stainless Steel pumps are explosion-proof Certified (ATEX)



Versatility

This pump handles Viscous fluids, Slurries, Solid laden fluids, Shear Sensitive fluids very well.
No Priming needed
No Foaming of fluid pumped
No Stall damages
Portable
Submerged operation capable

Performance Graphs SDP 12 ALS/ALH

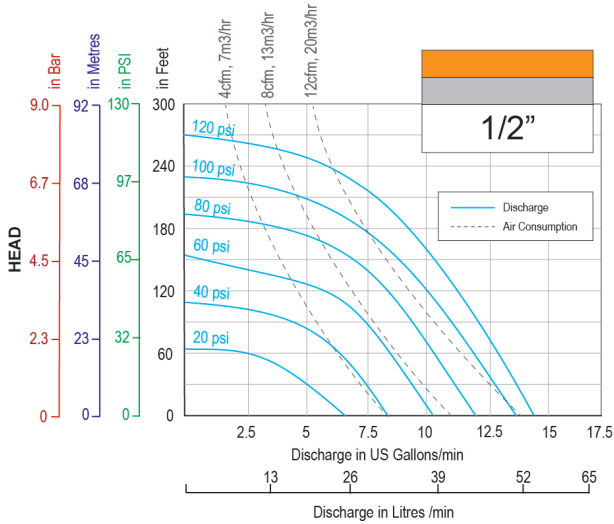

Performance Graphs SDP 12 ALT

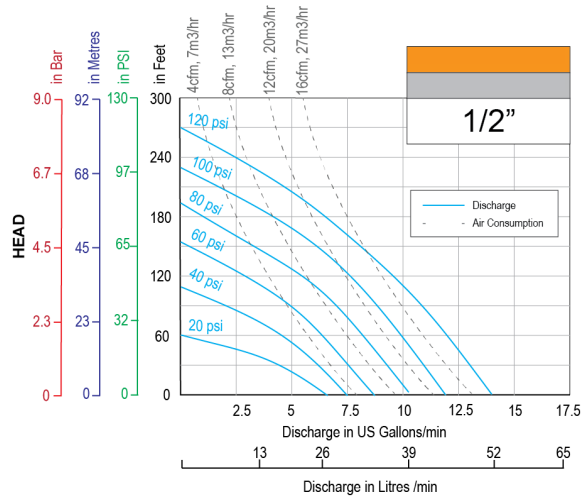

- Performance as measured pumping water at 20degC.
- **Disclaimer:** Actual pump performance may vary depending on number of bends, suction needed and friction in length of discharge piping.
- For guidance on how to select a suitable pump, visit Teryair AODD pump Selection guide.

Technical Data SDP 12ALX

	SDP 12AL with Santoprene / Hytrel / fitments	SDP 12AL with PTFE fitments
Maximum Discharge	55 Litres/min (15 US gallons/min)	51 literes/min (14 US gallons/min)
Suction Head Dry	5.5 meters, 18 feet	4 meters, 13 feet
Suction Head Wet	9.5 meters, 31 feet	9.5 meters, 31 feet
Pump Weight	5.1Kgs, 11.2 lbs	5.1Kgs, 11.2 lbs
Max Solid Passage	1.6 mm (1/16")	1.6 mm (1/16")
Air Distribution System	SDP MaxFlo, MOC aluminium, acetal and CFT seals	SDP MaxFlo, MOC aluminium, acetal and CFT seals
Balls / Seals	Santoprene or Hytrel	PTFE
Air Inlet	1/2" NPT	1/2" NPT
Fluid Inlet, Fluid Outlet	1/2" NPT/BSPT/BSPP	1/2" NPT/BSPT/BSPP

Dimensions SDP 12ALX

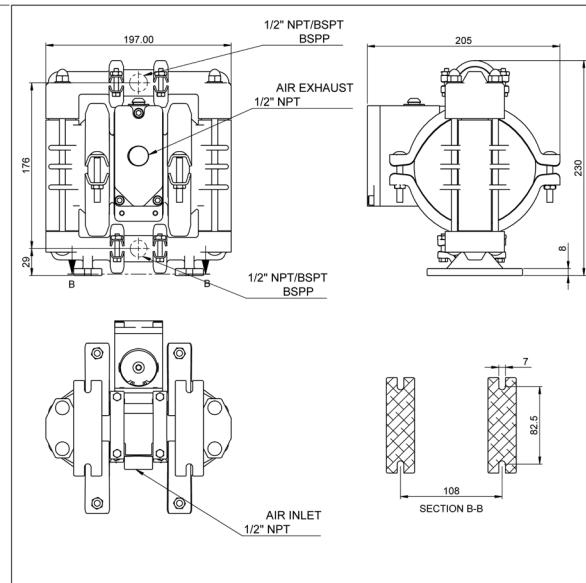

Pump Nomenclature







XX	XX	XX	X	X	X
Air Valve Type	Pump Size	Material of Construction	Material of Diaphragm	Bolted or Clamped	Threading on Inlet and Outlet
DP - Classic ADP - Advanced SDP - MaxFlo	06 - 1/4"	AL - Aluminium	B - Nitrile N - Neoprene S - Santoprene T - PTFE V - Viton H - Hytel	B - Bolted C - Clamped	R- NPT G - BSPT P - BSPP F - Flanged
	12 - 1/2"				
	15 - 1/2"	SS - Stainless Steel 316L			
	25 - 1"				
	40 - 1 - 1/2"	PP - Polypropylene			
	50 - 2 "				
	75- 3"	CI - Ductile Iron			
100 - 4"					

Air Valve Replacement Kits for SDP 12 ALX Pumps

Air Valve Replacement Kit consists of a complete operational air valve assembly complete. Consisting of Air Valve Body, End Plates, Spool and all seals, o rings and gaskets.

Replacement KIT Ordering No	Suitable for
167 97 02	NPT Fitted ALX Pumps With Any Diaphragm Variant BSPT Fitted ALX Pumps With Any Diaphragm Variant BSPP Fitted ALX Pumps With Any Diaphragm Variant

Diaphragm specifications

Neoprene		An excellent general-purpose diaphragm for use in non-aggressive applications such as water-based slurries, well water or sea water. Exhibits excellent flex life and low cost. Temperature range -18°C to +93°C (0°F to +200°F)
Nitile		Excellent for applications involving petroleum / oil-based fluids such as leaded gasolines, fuel oils, non-synthetic hydraulic oils, kerosene, turpentine and motor oils. Temperature range -12°C to +82°C (+10°F to +180°F)
Santoprene		Good abrasion resistance. Low cost. Can handle mild acids and alkalis well. Excellent low cost alternative to ptfе. Excellent suction capabilities Excellent general purpose diaphragm. Temperature range -40°C to +107°C (-40F to +225°F)
HytreI		Good abrasion resistance. Low cost. . Excellent suction capabilities Good general purpose diaphragm. Temperature range -29°C to +104°C (-20°F to +220°F)
Viton		Excellent for use in applications requiring extremely hot temperatures. May also be used with aggressive fluids such as aromatic or chlorinated hydrocarbons and highly aggressive acids. Especially where high suction lift is important. Temperature range -40°C to +175°C (-40°F to +350°F)
PTFE		Excellent choice when pumping highly aggressive fluids such as aromatic or chlorinated hydrocarbons, acids, caustics, ketones and acetates. Temperature range +4°C to +104°C (+40°F to +220°F)

note: not all diaphragms may be available with this pump, see page 1 for diaphragm options for this pump.

Repair Kits for SDP 12 ALX/SSX Pumps

Repair Kits consist of everything you need to quickly restore the pump. Repair Kits contain one set of Diaphragms, one set of balls, one set of seats or seats+Orings, secondary shaft complete with seals, air valve spool complete with fitted seals, all gaskets, end caps with fitted rings and other wear parts needed to rebuild the pump. Repair kits are threading independent.

Repair KIT Ordering No	Suitable for
164 97 01S	SDP 12 ALS / SSS
164 97 01H	SDP 12 ALH / SSH
164 97 01T	SDP 12 ALT / SST

SUMMARY FOR THE ATEX RATING FOR TERYAIR AODD MODELS

Pump Size	Series	Wetted Materials	Center Section	Diphargm Materials	ATEX Rating
06 (1/4")	SDP	Aluminium	Aluminium	Neoprene	II 2 GD Ex h IIC T6 Gb Ex h IIIC T85°C Db (IP65)
				Buna-N	
				Viton-FKM	II 2 GD Ex h IIC T3 Gb Ex h IIIC T200°C Db (IP65)
				Sentoprene	II 2 GD Ex h IIC T5 Gb Ex h IIIC T100°C Db (IP65)
				Hytrel	
				PTFE	
		Stainless Steel	Stainless Steel	Neoprene	II 2 GD Ex h IIC T6 Gb Ex h IIIC T85°C Db I M2 Ex h I Mb (IP65)
				Buna-N	
				Viton-FKM	II 2 GD Ex h IIC T3 Gb Ex h IIIC T200°C Db (IP65) I M2 Ex h I Mb (IP65)
				Sentoprene	II 2 GD Ex h IIC T5 Gb Ex h IIIC T100°C Db (IP65) I M2 Ex h I Mb (IP65)
				Hytrel	
				PTFE	
12 (1/2")	DP/SDP	Aluminium	Aluminium	Neoprene	II 2 GD Ex h IIC T6 Gb Ex h IIIC T85°C Db (IP65)
				Buna-N	
				Viton-FKM	II 2 GD Ex h IIC T3 Gb Ex h IIIC T200°C Db (IP65)
				Sentoprene	II 2 GD Ex h IIC T5 Gb Ex h IIIC T100°C Db (IP65)
				Hytrel	
				PTFE	
	SDP	Stainless Steel	Stainless Steel	Neoprene	II 2 GD Ex h IIC T6 Gb Ex h IIIC T85°C Db I M2 Ex h I Mb (IP65)
				Buna-N	
				Viton-FKM	II 2 GD Ex h IIC T3 Gb Ex h IIIC T200°C Db (IP65) I M2 Ex h I Mb (IP65)
				Sentoprene	II 2 GD Ex h IIC T5 Gb Ex h IIIC T100°C Db (IP65) I M2 Ex h I Mb (IP65)
				Hytrel	
				PTFE	
25 (1")	DP / SDP	Aluminium / Stainless Steel	Aluminium	Neoprene	II 2 GD Ex h IIC T6 Gb Ex h IIIC T85°C Db (IP65)
				Buna-N	
				Viton-FKM	II 2 GD Ex h IIC T3 Gb Ex h IIIC T200°C Db (IP65)
				Sentoprene	II 2 GD Ex h IIC T5 Gb Ex h IIIC T100°C Db (IP65)
				Hytrel	
				PTFE	

SUMMARY FOR THE ATEX RATING FOR TERYAIR AODD MODELS

Pump Size	Series	Wetted Materials	Center Section	Diphragm Materials	ATEX Rating
40 (1-1/2")	DP / SDP	Aluminium / Stain- less Steel	Aluminium	Neoprene	II 2 GD Ex h IIC T6 Gb Ex h IIIC T85°C Db (IP65)
				Buna-N	
				Viton-FKM	II 2 GD Ex h IIC T3 Gb Ex h IIIC T200°C Db (IP65)
				Sentoprene	II 2 GD Ex h IIC T5 Gb Ex h IIIC T100°C Db (IP65)
				Hytrel	
				PTFE	
50 (2")	DP / SDP	Aluminium / Stain- less Steel	Aluminium	Neoprene	II 2 GD Ex h IIC T6 Gb Ex h IIIC T85°C Db (IP65)
				Buna-N	
				Viton-FKM	II 2 GD Ex h IIC T3 Gb Ex h IIIC T200°C Db (IP65)
				Sentoprene	II 2 GD Ex h IIC T5 Gb Ex h IIIC T100°C Db (IP65)
				Hytrel	
				PTFE	
	SDP	Cast Iron	Cast Iron	Neoprene	II 2 GD Ex h IIC T6 Gb Ex h IIIC T85°C Db I M2 Ex h I Mb (IP65)
				Buna-N	
				Viton-FKM	"II 2 GD Ex h IIC T3 Gb Ex h IIIC T200°C Db (IP65) I M2 Ex h I Mb (IP65) "
				Sentoprene	II 2 GD Ex h IIC T5 Gb Ex h IIIC T100°C Db (IP65) I M2 Ex h I Mb (IP65)
				Hytrel	
				PTFE	
75 (3")	DP / SDP	Aluminium	Aluminium	Neoprene	II 2 GD Ex h IIC T6 Gb Ex h IIIC T85°C Db (IP65)
				Buna-N	
				Viton-FKM	II 2 GD Ex h IIC T3 Gb Ex h IIIC T200°C Db (IP65)
				Sentoprene	II 2 GD Ex h IIC T5 Gb Ex h IIIC T100°C Db (IP65)
				Hytrel	
				PTFE	
	SDP	Cast Iron	Cast Iron	Neoprene	II 2 GD Ex h IIC T6 Gb Ex h IIIC T85°C Db I M2 Ex h I Mb (IP65)
				Buna-N	
				Viton-FKM	II 2 GD Ex h IIC T3 Gb Ex h IIIC T200°C Db (IP65) I M2 Ex h I Mb (IP65)
				Sentoprene	II 2 GD Ex h IIC T5 Gb Ex h IIIC T100°C Db (IP65) I M2 Ex h I Mb (IP65)
				Hytrel	
				PTFE	