

## **DP 40 ALX**

MAX DISCHARGE

**0-263 litres/minute**

SIZE, MATERIAL

**1-1/2", Aluminium**

WEIGHT

**15 Kgs**



## **AIR OPERATED DIAPHRAGM PUMP**

*These aluminium constructed pumps are commonly combined with Neoprene, Nitrile, Santoprene, Hytrel, Viton or PTFE Elastomers. With these elastomers they are ideal for pumping of water and water-based fluids, non-aggressive fluids, oily fluids and fluids having low acidic or alkali concentrations*

*Aluminium Pumps offer a relatively low-cost solution to many pumping applications. For this purpose, the main industries that choose Aluminium pumps are Paints, Marine, Mining, Ceramic and Wastewater/Pollution management.*



### **Diaphragm Options 'X'**

Neoprene  
Nitrile  
Santoprene  
Hytrel  
Viton  
PTFE



### **Approvals and Certifications**

All Teryair pumps are CE marked and manufactured under an ISO 9001:2015 Quality system by SGS. All Teryair aluminum, Ductile iron, and Stainless Steel pumps are explosion-proof Certified (ATEX).



### **Versatility**

This pump handles Viscous fluids, Slurries, Solid laden fluids, Shear Sensitive fluids very well.  
No Priming needed  
No Foaming of fluid pumped  
No Stall damages  
Portable  
Submerged operation capable

## Performance Graphs DP 40 ALN/ALB/ALS/ALH/ALV

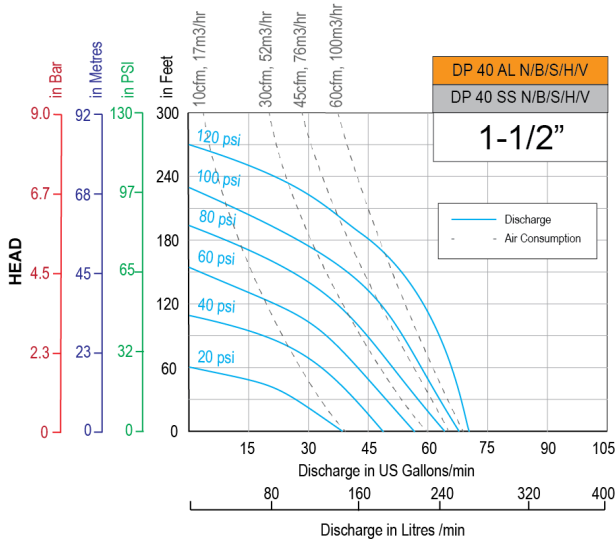

## Performance Graphs DP 40 ALT

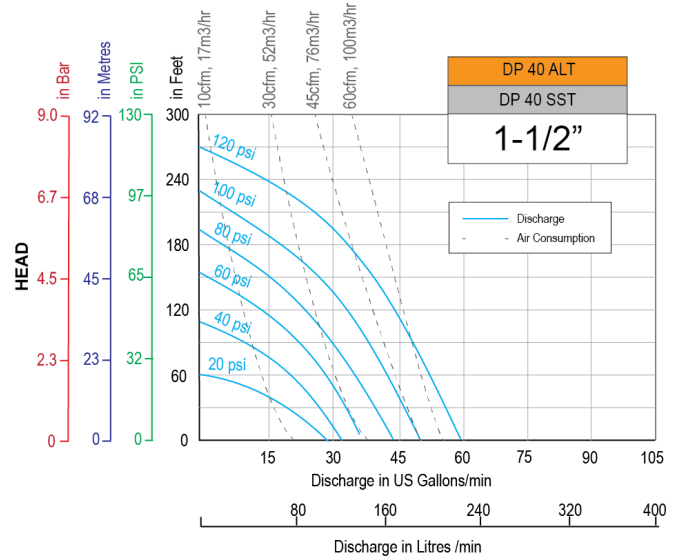

- Performance as measured pumping water at 20degC.
- **Disclaimer:** Actual pump performance may vary depending on number of bends, suction needed and friction in length of discharge piping.
- For guidance on how to select a suitable pump, visit Teryair AODD pump Selection guide.

## Technical Data DP 40ALX

|                           | DP 40AL with Neoprene / Nitrile / Santoprene / Hytrel / Viton fitments | DP 40AL with PTFE Fitments  |
|---------------------------|--|---|
| Maximum Discharge         | 263 Litres/min (70 US gallons/min)                                     | 223 Litres/min (59 US gallons/min)                                  |
| Suction Head Dry          | 5.5 meters, 18 feet  | 2.7 meters, 9 feet  |
| Suction Head Wet          | 8.5 meters, 28 feet  | 8.5 meters, 28 feet   |
| Pump Weight               | 15 Kgs, 33 lbs   | 15.5 Kgs, 34 lbs  |
| Max Solid Passage         | 4.8 mm (3/16")   | 4.8 mm (3/16")  |
| Air Distribution System   | Classic-Rugged Bronze Valve Body with Hard Anodized Aluminium Spool    | Classic-Rugged Bronze Valve Body with Hard Anodized Aluminium Spool |
| Balls / Seals             | Santoprene or Hytrel or Nitrile or Neoprene or Viton                   | PTFE  |
| Air Inlet                 | 1/2" NPT/BSPT/BSPP   | 1/2" NPT/BSPT/BSPP  |
| Fluid Inlet, Fluid Outlet | 1-1/2" NPT/BSPT/BSPP, 1-1/4" NPT/BSPT/BSPP                             | 1-1/2" NPT/BSPT/BSPP, 1-1/4" NPT/BSPT/BSPP                          |

## Dimensions DP 40 ALX

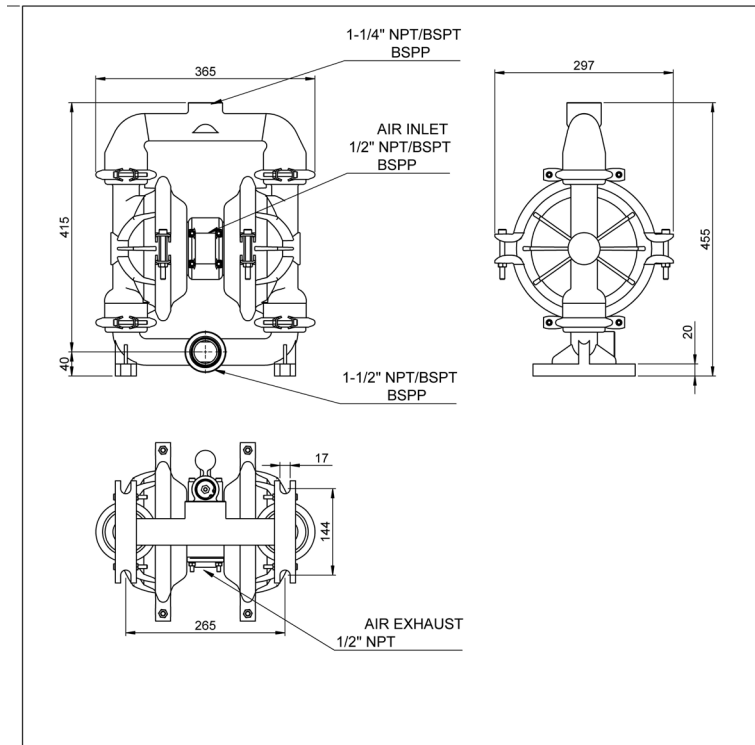

## Pump Nomenclature







| XX             | XX            | XX                        | X  | X                             | X  |
|----------------|---------------|---------------------------|--|-------------------------------|--|
| Air Valve Type | Pump Size     | Material of Construction  | Material of Diaphragm  | Bolted or Clamped             | Threading on Inlet and Outlet                              |
| DP - Classic   | 06 - 1/4"     | AL - Aluminium            | B - Nitrile<br>N - Neoprene<br>S - Santoprene<br>T - PTFE<br>V - Viton<br>H - Hytrel | B - Bolted<br><br>C - Clamped | R - NPT<br><br>G - BSPT<br><br>P - BSPP<br><br>F - Flanged |
|                | 12 - 1/2"     |                           |  |                               |  |
| ADP - Advanced | 15 - 1/2"     |                           |  |                               |  |
| SDP - MaxFlo   | 25 - 1"       | SS - Stainless Steel 316L |  |                               |  |
|                | 40 - 1 - 1/2" | PP - Polypropylene        |  |                               |  |
|                | 50 - 2"       | CI - Ductile Iron         |  |                               |  |
|                | 75 - 3"       |                           |  |                               |  |
|                | 100 - 4"      |                           |  |                               |  |

## Air Valve Replacement Kits for DP 40 ALX Pumps

Air Valve Replacement Kit consists of a complete operational air valve assembly complete. Consisting of Air Valve Body, End Plates, Spool and all seals, o rings and gaskets.

| Replacement KIT Ordering No | Suitable for  |
|-----------------------------|---|
| 151 97 03                   | NPT Fitted ALX or SSX Pumps With Any Diaphragm Variant  |
| 151 97 04                   | BSPT Fitted ALX or SSX Pumps With Any Diaphragm Variant |
| 151 97 05                   | BSPP Fitted ALX or SSX Pumps With Any Diaphragm Variant |

### Diaphragm specifications

|            |   |  |
|------------|---|--|
| Neoprene   |    | An excellent general-purpose diaphragm for use in non-aggressive applications such as water-based slurries, well water or sea water. Exhibits excellent flex life and low cost. Temperature range -18°C to +93°C (0°F to +200°F)   |
| Nitile     |    | Excellent for applications involving petroleum / oil-based fluids such as leaded gasolines, fuel oils, non-synthetic hydraulic oils, kerosene, turpentine and motor oils. Temperature range -12°C to +82°C (+10°F to +180°F)   |
| Santoprene |    | Good abrasion resistance. Low cost. Can handle mild acids and alkalis well. Excellent low cost alternative to ptfе. Excellent suction capabilities Excellent general purpose diaphragm. Temperature range -40°C to +107°C (-40F to +225°F)   |
| Hytrel     |    | Good abrasion resistance. Low cost. . Excellent suction capabilities Good general purpose diaphragm. Temperature range -29°C to +104°C (-20°F to +220°F)   |
| Viton      |  | Excellent for use in applications requiring extremely hot temperatures. May also be used with aggressive fluids such as aromatic or chlorinated hydrocarbons and highly aggressive acids. Especially where high suction lift is important. Temperature range -40°C to +175°C (-40°F to +350°F) |
| PTFE       |  | Excellent choice when pumping highly aggressive fluids such as aromatic or chlorinated hydrocarbons, acids, caustics, ketones and acetates. Temperature range +4°C to +104°C (+40°F to +220°F)   |

*note: not all diaphragms may be available with this pump, see page 1 for diaphragm options for this pump.*

### Repair Kits for DP 40 ALX Pumps

Repair Kits consist of everything you need to quickly restore the pump. Repair Kits contain one set of Diaphragms, one set of balls, one set of seats or seats+Orings, air valve spool complete, all gaskets, end caps with fitted rings. Repair kits are threading independant.

| Repair KIT Ordering No | Suitable for |
|------------------------|--------------|
| 151 97 06N             | DP 40 ALN    |
| 151 97 06B             | DP 40 ALB    |
| 151 97 06S             | DP 40 ALS    |
| 151 97 06H             | DP 40 ALH    |
| 151 97 06V             | DP 40 ALV    |
| 151 97 06T             | DP 40 ALT    |

SUMMARY FOR THE ATEX RATING FOR TERYAIR AODD MODELS

| Pump Size    | Series   | Wetted Materials            | Center Section  | Diphargm Materials | ATEX Rating  |
|--------------|----------|-----------------------------|-----------------|--------------------|--|
| 06<br>(1/4") | SDP      | Aluminium                   | Aluminium       | Neoprene           | II 2 GD Ex h IIC T6 Gb<br>Ex h IIIC T85°C Db (IP65)                                  |
|              |          |                             |                 | Buna-N             |  |
|              |          |                             |                 | Viton-FKM          | II 2 GD Ex h IIC T3 Gb<br>Ex h IIIC T200°C Db (IP65)                                 |
|              |          |                             |                 | Sentoprene         | II 2 GD Ex h IIC T5 Gb<br>Ex h IIIC T100°C Db (IP65)                                 |
|              |          |                             |                 | Hytrel             |  |
|              |          |                             |                 | PTFE               |  |
|              |          | Stainless Steel             | Stainless Steel | Neoprene           | II 2 GD Ex h IIC T6 Gb<br>Ex h IIIC T85°C Db<br><b>I M2 Ex h I Mb (IP65)</b>         |
|              |          |                             |                 | Buna-N             |  |
|              |          |                             |                 | Viton-FKM          | II 2 GD Ex h IIC T3 Gb<br>Ex h IIIC T200°C Db (IP65)<br><b>I M2 Ex h I Mb (IP65)</b> |
|              |          |                             |                 | Sentoprene         | II 2 GD Ex h IIC T5 Gb<br>Ex h IIIC T100°C Db (IP65)<br><b>I M2 Ex h I Mb (IP65)</b> |
|              |          |                             |                 | Hytrel             |  |
|              |          |                             |                 | PTFE               |  |
| 12<br>(1/2") | DP/SDP   | Aluminium                   | Aluminium       | Neoprene           | II 2 GD Ex h IIC T6 Gb<br>Ex h IIIC T85°C Db (IP65)                                  |
|              |          |                             |                 | Buna-N             |  |
|              |          |                             |                 | Viton-FKM          | II 2 GD Ex h IIC T3 Gb<br>Ex h IIIC T200°C Db (IP65)                                 |
|              |          |                             |                 | Sentoprene         | II 2 GD Ex h IIC T5 Gb<br>Ex h IIIC T100°C Db (IP65)                                 |
|              |          |                             |                 | Hytrel             |  |
|              |          |                             |                 | PTFE               |  |
|              | SDP      | Stainless Steel             | Stainless Steel | Neoprene           | II 2 GD Ex h IIC T6 Gb<br>Ex h IIIC T85°C Db<br><b>I M2 Ex h I Mb (IP65)</b>         |
|              |          |                             |                 | Buna-N             |  |
|              |          |                             |                 | Viton-FKM          | II 2 GD Ex h IIC T3 Gb<br>Ex h IIIC T200°C Db (IP65)<br><b>I M2 Ex h I Mb (IP65)</b> |
|              |          |                             |                 | Sentoprene         | II 2 GD Ex h IIC T5 Gb<br>Ex h IIIC T100°C Db (IP65)<br><b>I M2 Ex h I Mb (IP65)</b> |
|              |          |                             |                 | Hytrel             |  |
|              |          |                             |                 | PTFE               |  |
| 25 (1")      | DP / SDP | Aluminium / Stainless Steel | Aluminium       | Neoprene           | II 2 GD Ex h IIC T6 Gb<br>Ex h IIIC T85°C Db (IP65)                                  |
|              |          |                             |                 | Buna-N             |  |
|              |          |                             |                 | Viton-FKM          | II 2 GD Ex h IIC T3 Gb<br>Ex h IIIC T200°C Db (IP65)                                 |
|              |          |                             |                 | Sentoprene         | II 2 GD Ex h IIC T5 Gb<br>Ex h IIIC T100°C Db (IP65)                                 |
|              |          |                             |                 | Hytrel             |  |
|              |          |                             |                 | PTFE               |  |

SUMMARY FOR THE ATEX RATING FOR TERYAIR AODD MODELS

| Pump Size      | Series      | Wetted Materials                 | Center Section | Diphragm Materials | ATEX Rating   |
|----------------|-------------|----------------------------------|----------------|--------------------|---|
| 40<br>(1-1/2") | DP /<br>SDP | Aluminium / Stain-<br>less Steel | Aluminium      | Neoprene           | II 2 GD Ex h IIC T6 Gb<br>Ex h IIIC T85°C Db (IP65)                                     |
|                |             |                                  |                | Buna-N             |   |
|                |             |                                  |                | Viton-FKM          | II 2 GD Ex h IIC T3 Gb<br>Ex h IIIC T200°C Db (IP65)                                    |
|                |             |                                  |                | Sentoprene         | II 2 GD Ex h IIC T5 Gb<br>Ex h IIIC T100°C Db (IP65)                                    |
|                |             |                                  |                | Hytrel             |   |
|                |             |                                  |                | PTFE               |   |
| 50 (2")        | DP /<br>SDP | Aluminium / Stain-<br>less Steel | Aluminium      | Neoprene           | II 2 GD Ex h IIC T6 Gb<br>Ex h IIIC T85°C Db (IP65)                                     |
|                |             |                                  |                | Buna-N             |   |
|                |             |                                  |                | Viton-FKM          | II 2 GD Ex h IIC T3 Gb<br>Ex h IIIC T200°C Db (IP65)                                    |
|                |             |                                  |                | Sentoprene         | II 2 GD Ex h IIC T5 Gb<br>Ex h IIIC T100°C Db (IP65)                                    |
|                |             |                                  |                | Hytrel             |   |
|                |             |                                  |                | PTFE               |   |
|                | SDP         | Cast Iron                        | Cast Iron      | Neoprene           | II 2 GD Ex h IIC T6 Gb<br>Ex h IIIC T85°C Db<br><b>I M2 Ex h I Mb (IP65)</b>            |
|                |             |                                  |                | Buna-N             |   |
|                |             |                                  |                | Viton-FKM          | "II 2 GD Ex h IIC T3 Gb<br>Ex h IIIC T200°C Db (IP65)<br><b>I M2 Ex h I Mb (IP65)</b> " |
|                |             |                                  |                | Sentoprene         | II 2 GD Ex h IIC T5 Gb<br>Ex h IIIC T100°C Db (IP65)<br><b>I M2 Ex h I Mb (IP65)</b>    |
|                |             |                                  |                | Hytrel             |   |
|                |             |                                  |                | PTFE               |   |
| 75 (3")        | DP /<br>SDP | Aluminium                        | Aluminium      | Neoprene           | II 2 GD Ex h IIC T6 Gb<br>Ex h IIIC T85°C Db (IP65)                                     |
|                |             |                                  |                | Buna-N             |   |
|                |             |                                  |                | Viton-FKM          | II 2 GD Ex h IIC T3 Gb<br>Ex h IIIC T200°C Db (IP65)                                    |
|                |             |                                  |                | Sentoprene         | II 2 GD Ex h IIC T5 Gb<br>Ex h IIIC T100°C Db (IP65)                                    |
|                |             |                                  |                | Hytrel             |   |
|                |             |                                  |                | PTFE               |   |
|                | SDP         | Cast Iron                        | Cast Iron      | Neoprene           | II 2 GD Ex h IIC T6 Gb<br>Ex h IIIC T85°C Db<br><b>I M2 Ex h I Mb (IP65)</b>            |
|                |             |                                  |                | Buna-N             |   |
|                |             |                                  |                | Viton-FKM          | II 2 GD Ex h IIC T3 Gb<br>Ex h IIIC T200°C Db (IP65)<br><b>I M2 Ex h I Mb (IP65)</b>    |
|                |             |                                  |                | Sentoprene         | II 2 GD Ex h IIC T5 Gb<br>Ex h IIIC T100°C Db (IP65)<br><b>I M2 Ex h I Mb (IP65)</b>    |
|                |             |                                  |                | Hytrel             |   |
|                |             |                                  |                | PTFE               |   |